

Kawasaki Teryx4 Steel Roof

Product Instructions | Part No: 29310

Application: Kawasaki Teryx4, verify accessory fitment at Kolpin.com.

Before You Begin: Read these instructions and check to be sure all parts and tools are accounted for. Please retain these installation instructions for future reference and parts ordering information.

Note: If any hardware is missing, do not return to the store. Call us to help, Toll Free 1-877-956-5746.

Note: Two people are required to install this Roof Kit.

Items marked (*) are included in Hardware Kit PN 29311.

This Kit includes:

Item	Qty	Part Description
1	1	Teryx4 Front Roof Panel
2	1	Teryx4 Rear Roof Panel
3*	10	Button Screw, Zinc Plated, M6-1.0 x 25mm LG
4*	10	Flange Locknut, Zinc Plated, M6-1.0
5*	10	Flat Washer, Zinc Plated, M6
6*	1	Rubber Overlap Trim Seal
7*	2	Clamp, Painted, 1.38" Diameter
8*	4	Foam Strip
9*	8	Clamp, Painted, 1.88" Diameter
10	1	Instruction Guide (not shown)

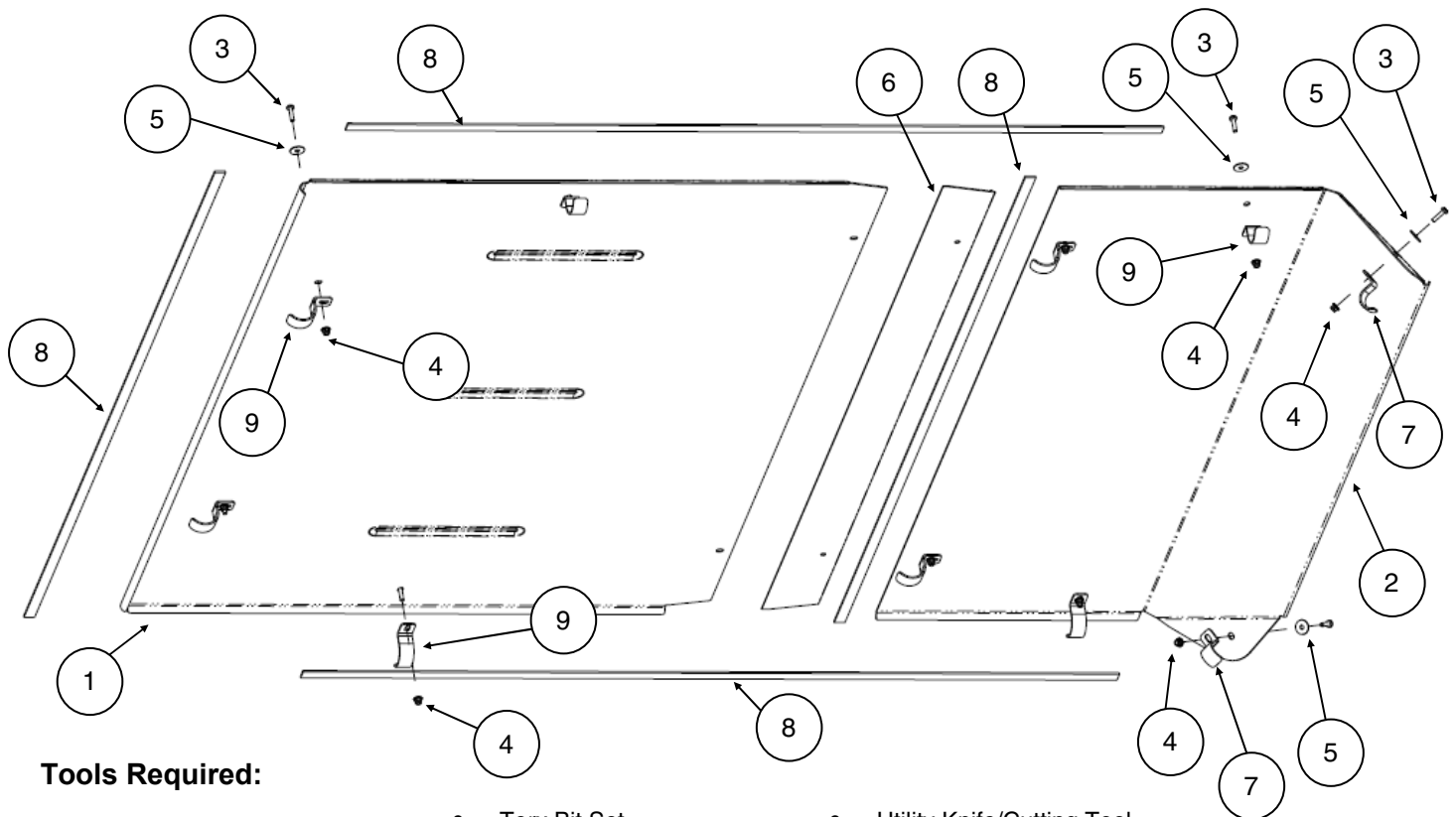

Tools Required:

- Socket Set, Metric
- Torx Bit Set
- Utility Knife/Cutting Tool
- Wrench Set, Metric
- Torque Wrench

Assembly Time: Approximately 25 minutes

Important: Your Kolpin Steel Roof Kit is exclusively designed for your vehicle. Please read the installation instructions thoroughly before beginning. Installation is easier if the vehicle is clean and free of debris. For your safety, and to ensure a satisfactory installation, perform all installation steps correctly in the sequence shown. For better cab assembly procedure, install kits in the following order: front window, and roof.

Installation Instructions:

1. Shift vehicle transmission into "NEUTRAL" and set parking brake. Turn key to "OFF" position and remove from vehicle.

2. Being careful not to scratch painted surfaces, place the front steel roof panel (item #1) onto rear steel roof panel (item #2). Fasten panels together by using two M6 screws (item #3) and two M6 washers (item #5) inserting through the holes at the overlapping seam as shown. Loosely secure the larger clamps (item #9) with M6 locknuts (item #4) on underside roof surface. (See illustrations 1-1 and 1-2).

Note, place rubber seal (item #6) in between the two roof panels as shown. Do not tighten hardware at this step since adjustments may be required later.

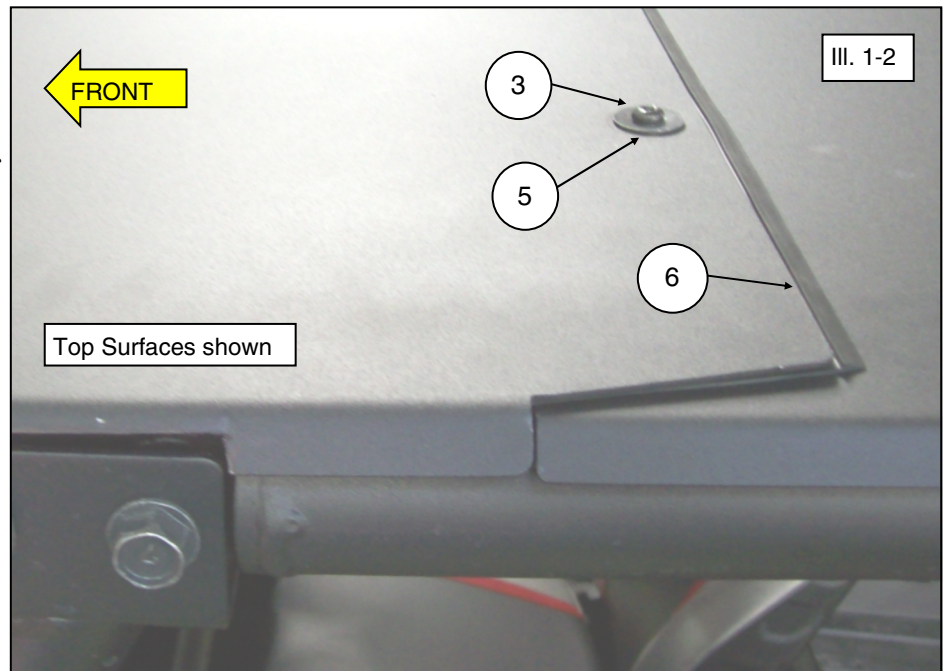
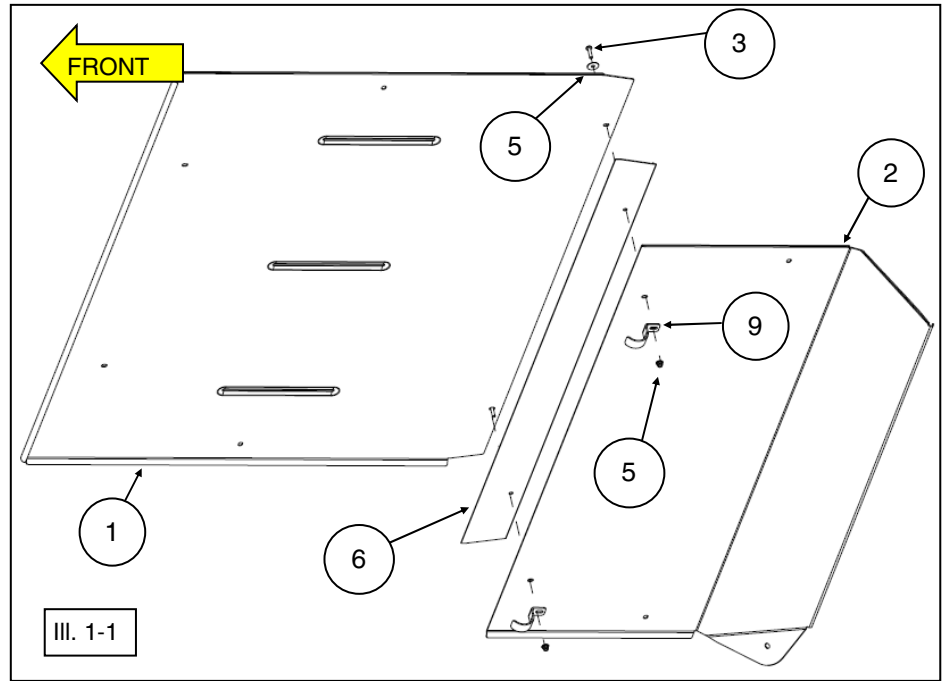

Installation Instructions (Continued):

3. Clean lower surface of front roof (item #1) and rear roof (item #2) as required, then apply foam strips (item #8) and as shown. Trim seals as required. (See illustration 1-3). **Note, foam strip alignment may be easier if roof assembly is placed on cab frame, then mark with pencil or tape where the roll cage tubes make contact with metal roof.**

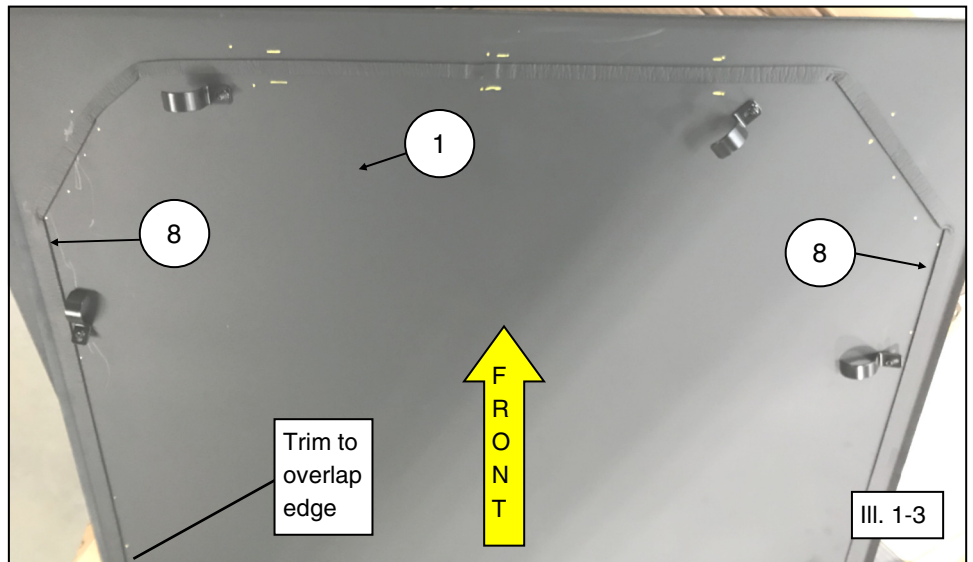

4. Place roof assembly on the top of the vehicle cab frame.

5. Align the center clamps (item #9) onto the middle cab frame tube, so that these can be fit onto the tube. (See illustration 1-4).

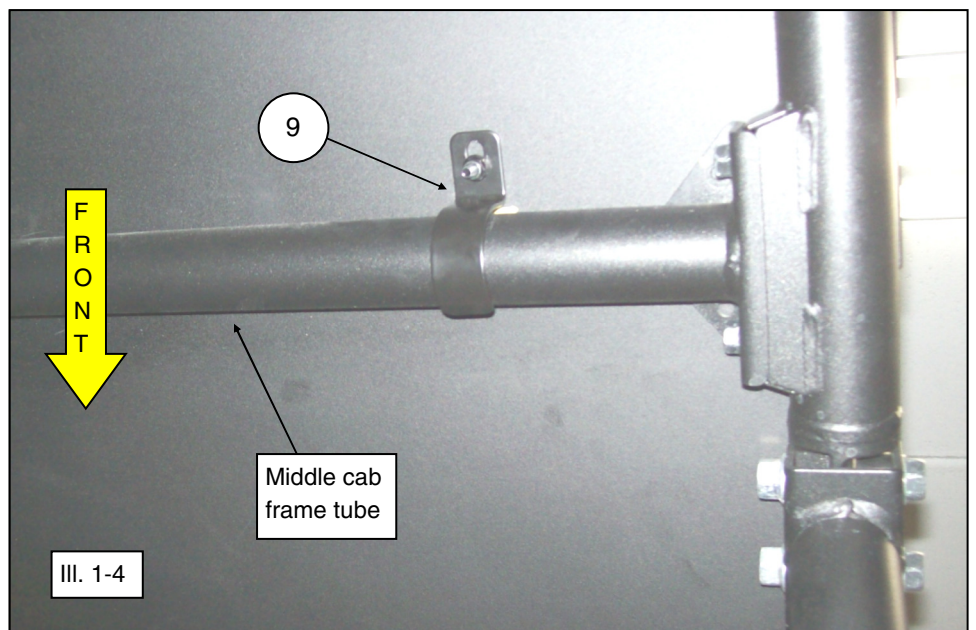

6. Secure the rear of the roof to the vehicle using the M6 screws (item #3) and M6 flat washers (item #5) through the top surface mounting holes. Attach the two smaller clamps (item #7) around rear cab frame tube and fasten with M6 locknuts (item #4). Align rear corners so small gap exists between cab frame and rear roof panel as shown. (See illustrations 1-5 and 1-6). **Note: Do not tighten hardware at this step since adjustments may be required later.**

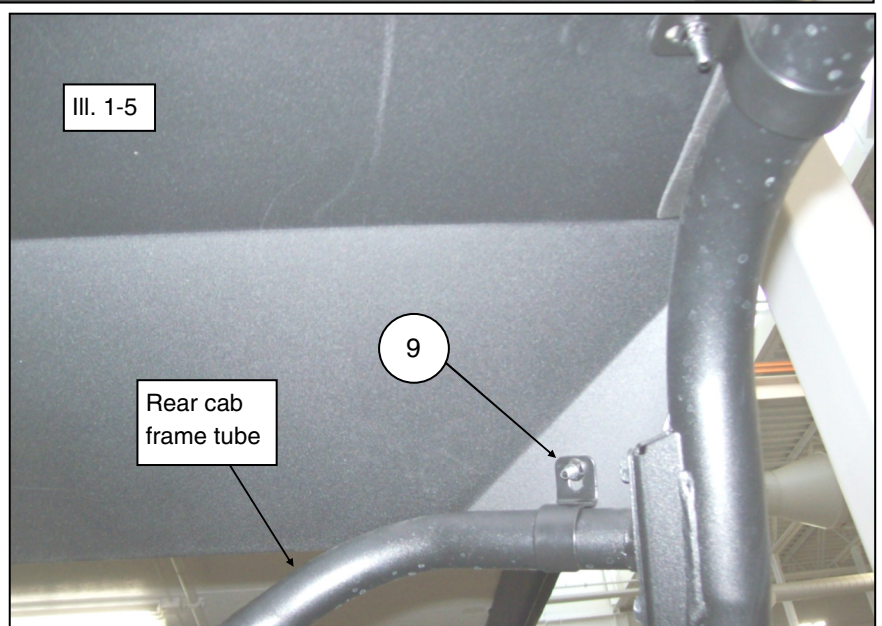

**Installation Instructions
(Continued):**



7. Continue to attach the larger clamps (item #9) around the cab frame at each of the slotted hole locations. Fasten using M6 screws (item #3) and flat washers (item #5) through the top surface. Secure clamps into position from lower surface with M6 locknuts (item #4) as shown. (See illustrations 1-7, 1-8 and 1-9).

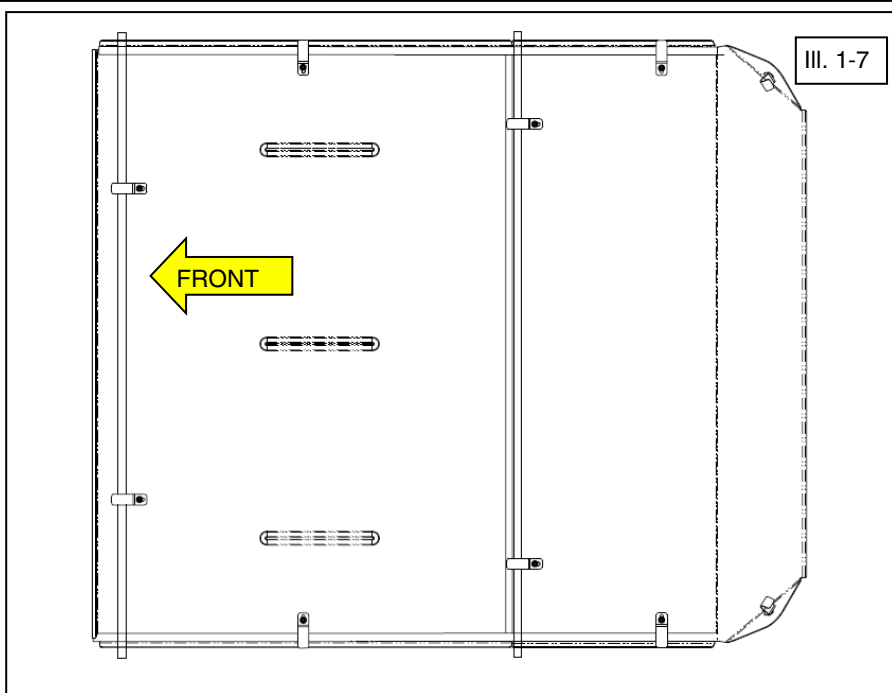

Installation Instructions (Continued):

8. Once roof panels are aligned onto cab frame, tighten all hardware to specifications.

 = T
6MM FASTENER TORQUE: 7 ft. lbs. (9.5 Nm)



Use and Care Information:

- Check the accessory mounts frequently and retighten hardware if necessary.
- Replace this accessory with a new one if it is damaged.
- Never use petroleum solvents such as gasoline, thinner, benzene, acid or alkaline cleaners.

For additional assistance, please contact Kolpin customer service department at (877) 956-5746 or (763) 478-5800 or email customerservice@kolpin.com

One Year Limited Warranty

For the period of one (1) year from the purchase date, Kolpin will replace for the original purchaser, free of charge, any part or parts found upon examination by Kolpin to be defective in material, workmanship, or both.

All transportation costs incurred submitting product to Kolpin for warranty consideration must be borne by the purchaser. If Kolpin determines that the product must be returned to the factory for credit, please call 1-877-956-5746 for a Return Merchandise Authorization (RMA) number and shipping instructions.

This warranty does not apply to parts that have been damaged by accident, alteration, abuse, improper maintenance, normal wear, or other causes beyond the manufacturer's control. In order to protect you and your ATV, certain parts of the accessory system and/or hardware are designed to fail when the equipment is over-stressed. Parts that are lost due to loosening and improper maintenance are not covered under warranty. This warranty does not cover removal or reinstallation labor fees of the plow system and related components.

Peripheral products such as engines, electric motors, and actuators may carry an original manufacturer's warranty. Most hardware is general in nature and is easily obtained locally. Be sure to replace with minimum metric class 8.8 specification.